

INSTALLATION AND OPERATING INSTRUCTIONS

In order to ensure complete and effective operation and for your own safety, all of the following instructions should be read carefully and observed.

■ DELIVERY

Sound insulation element for wall sleeve (SWS) is packaged with shrink wrapped. The window version (SSC) is packaged in a corrugated box.

■ RECEIPT

The shipment must be checked for damage and correctness immediately upon delivery. If there is any damage, promptly report the damage by consulting the transport company. If complaints are not made within the agreed period, any claims could be lost.

■ STANDARD SOUND LEVEL DIFFERENCE $D_{n,e,w}$

Each installed sound insulation element (SWS and SSC) improves the standard sound level difference $D_{n,e,w}$ by 2 dB on average.

■ SOUND PRESSURE LEVEL L_{pA}

Each installed sound insulation element SWS reduces the sound pressure level L_{pA} of the unit by 1 dB on average.

■ STORAGE

The storage location must be water-protected and free from temperature fluctuations. Persistent direct UV irradiation must be avoided. Damages due to improper transportation, storage or commissioning must be verified and are not liable warranty.

■ AREA OF APPLICATION

For effective sound insulation in a decentralised ventilation unit. In order to increase the sound insulation, the sound insulation elements can also be mounted in series one behind the other.

■ ADVANTAGES

- Optimum external sound insulation
- Optimum reduction of unit sounds
- Simple installation by inserting into the wall sleeve or soffit screen
- The loss of flow is approx. 1% per sound insulation element SWS and approx. 2% per SSC due to the flow-optimised geometry.

■ MATERIAL

- Open-cell foam made from melamine resin
- The product meets fire protection class B1 according to DIN 4102-1

■ INSTALLATION

Sound Insulation Element for wall sleeve (SWS)

First, insert the unit into the wall sleeve. Sound insulation elements can be inserted between the unit and the inside panel.

The recess in the circumferential edge of the sound insulation element acts as a cable guide and must be at the bottom. The sound insulation elements must be installed aligned with each other, note the orientation of the air ducts, see Fig.2.

NOTE: The sound insulation elements have a central slot, so that they can be lined up on a metre stick for simple insertion into the wall sleeve!

Sound Insulation Element for window wall (SSC)

Once the wall grill is removed, up to three sound insulation elements SSC hooked to each other can be inserted into the window wall channel. The central rail must be in the direction of the house wall, see Fig. 2. The SSC should be inserted deep enough into the screen that it is still accessible by hand for removal.

■ MAINTENANCE / CLEANING

In order to ensure proper functioning, the sound insulation elements should be checked during each filter change and carefully vacuumed with a vacuum cleaner, if necessary.

■ ACCESSORIES

The use of accessories which are not recommended or offered by Airflow is not permitted. Any potential damage is not covered by warranty.

■ WARRANTY CLAIMS – EXCLUSION OF LIABILITY

If the instructions in this documentation are not observed, all warranty claims shall be excluded.

This also applies to any liability claims extended to the manufacturer.

■ REGULATIONS – GUIDELINES

If the installation and operating instructions are observed, the product conforms to the applicable international regulations.

SWS is the Sound insulation element for wall sleeve installation. SSC is the Sound insulation element for window channel kit installation.

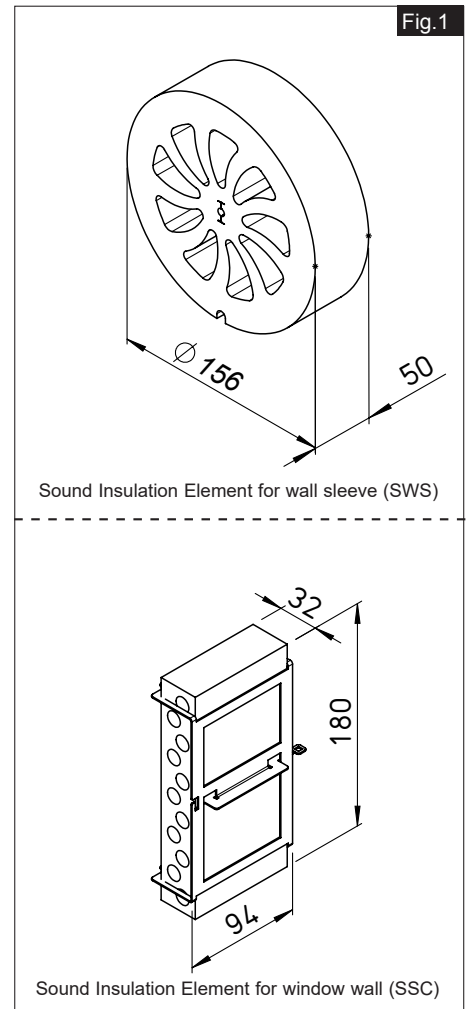
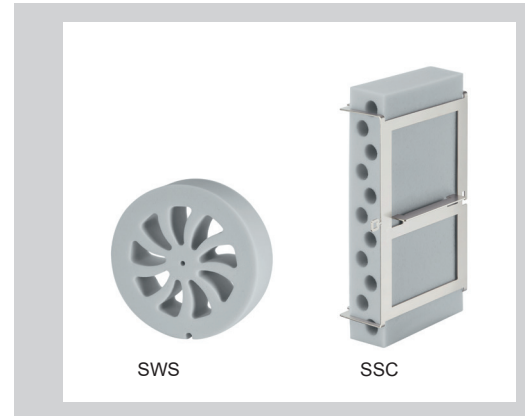

Standard sound level difference $D_{n,e,w}$

	Unohab ventilation unit	Sound Insulation Element for wall sleeve (SWS)	Insect screen	Sound Insulation Element for window wall (SSC)
$D_{n,e,w}$	44 dB	-2 dB/unit (max. -8 dB)	-3 dB	-2 dB/unit (max. -6 dB)

Fig.2

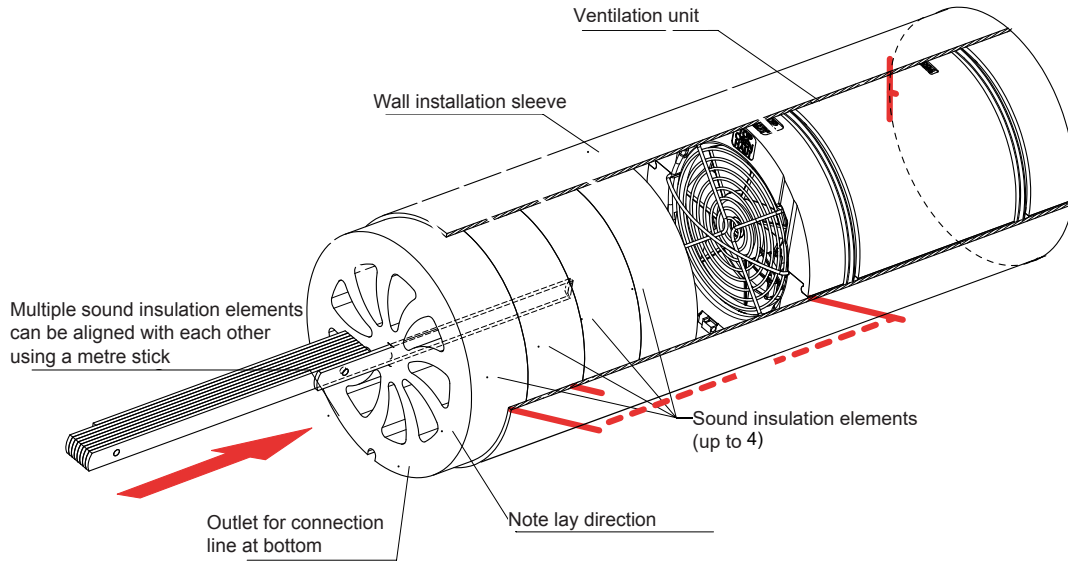

Sound Insulation Element for wall sleeve (SWS)

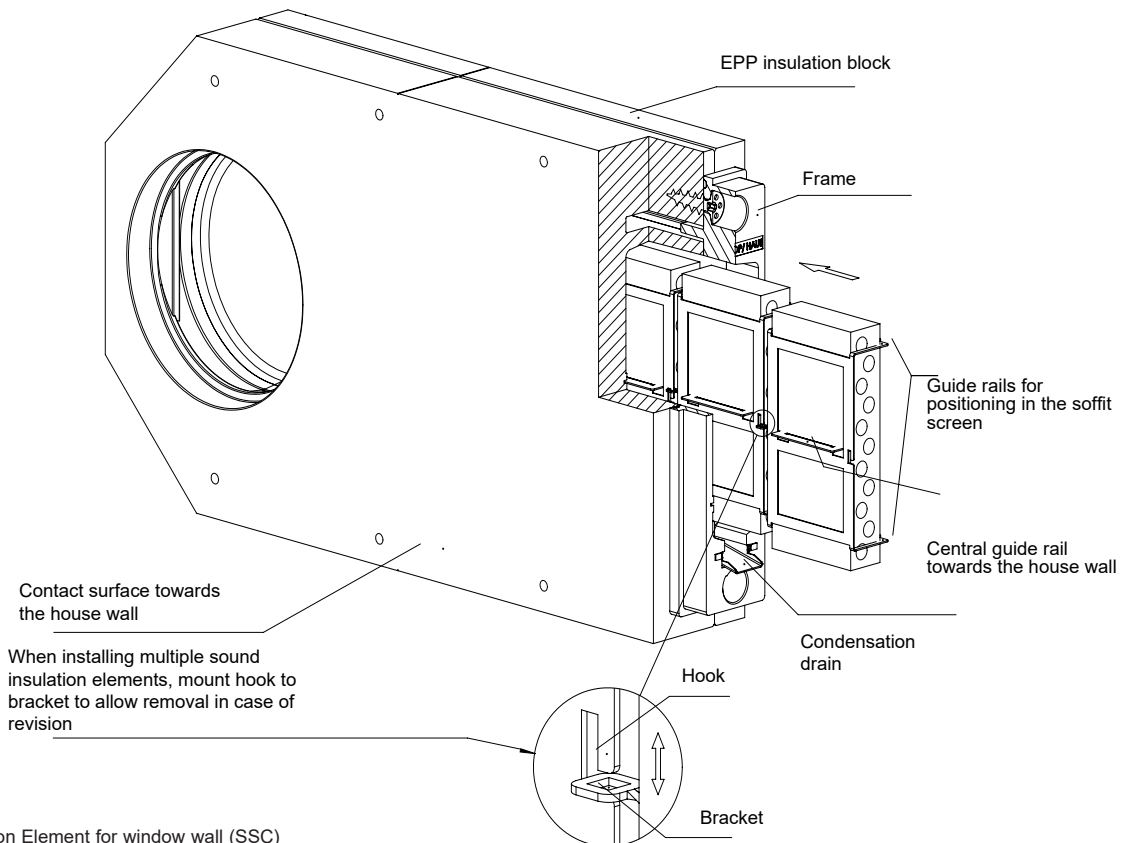

Sound Insulation Element for window wall (SSC)

Call: 01494 525252

Visit: airflow.com

80000790 - Issue 3 01/21